

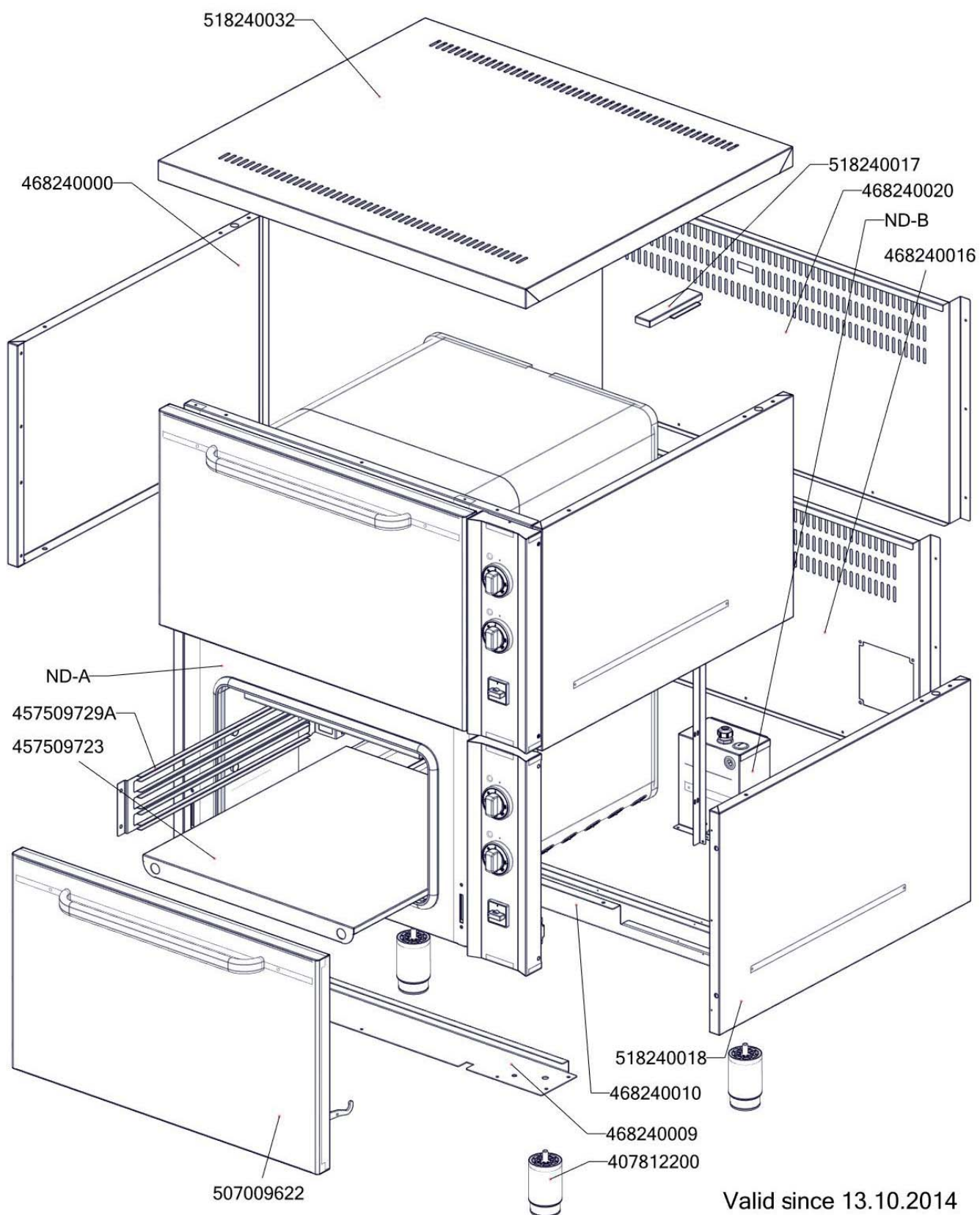

**EPP 02 S**  
**od 2014**

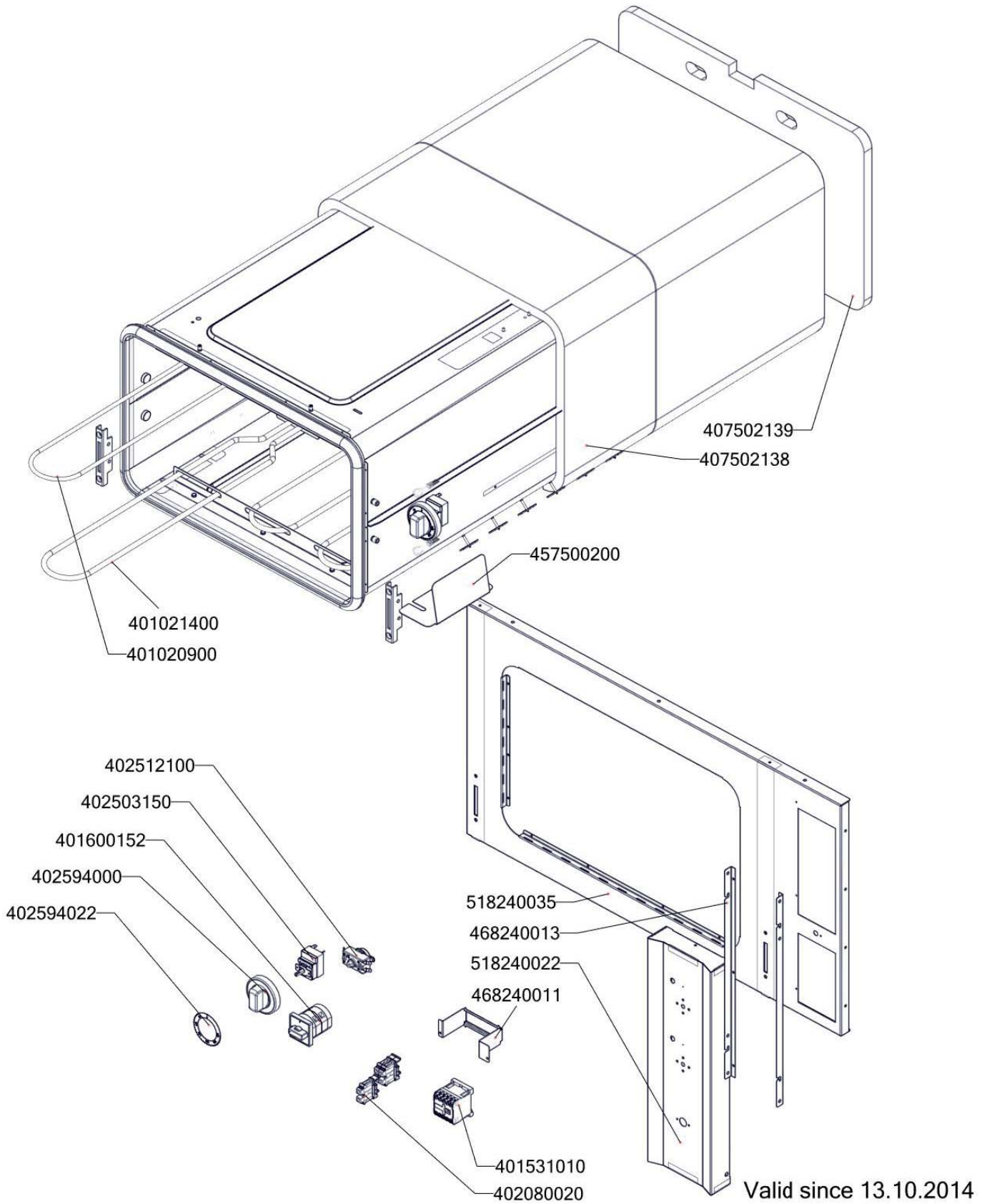

**EPP 02 S**  
**od 2014**  
**ND\_A**



**EPP 02 S**  
**od 2014**  
**ND\_B**

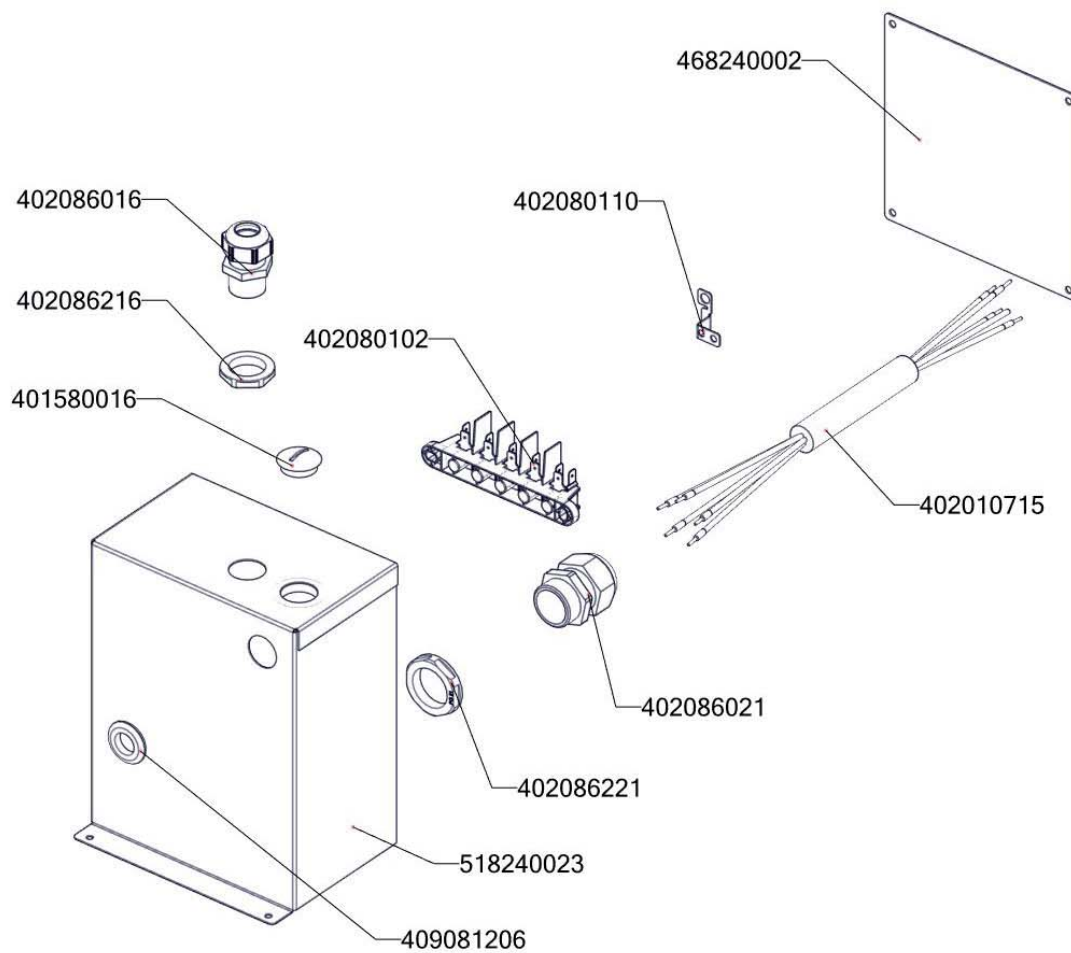

Valid since 13.10.2014